

mcafee



Ballycastle

Thursday 24th September @ 6.30pm

Conditions

1. The highest approved bidder shall be the purchaser. The Auctioneer reserves the right to refuse any bid, and should any dispute arise between two or more bidders, the lot or lots in dispute shall be put up again, or not, and resold at the discretion of the Auctioneer, or the auctioneer may declare the purchaser. The Auctioneer reserves the right to bid on behalf of the vendor up to and including any reserve price placed on any lot and to alter, divide, group or withdraw any lot or lots either before or at any time during the sale.
2. The Auctioneer shall regulate the bidding and no bid shall be retracted.
3. Every purchaser shall give his name and place of abode, in default of which the Auctioneers shall have the power to resell at once, or afterwards as they may think fit.
4. Each bidder shall be supposed to have seen and to be thoroughly acquainted with the contents and conditions of the lot or lots on which he may bid, and no allowance whatsoever will be made for any faults, imperfections or errors of any description. The measurements and quantities described in the Catalogue are believed to be correct and must be taken as such. The purchaser being held to have satisfied himself as to measurements and quantities and other specifications in the Catalogue before bidding, neither will the Auctioneers or the Vendors be responsible for any lot or parts of any lot after the fall of the hammer, from which time all lots purchased are at the risk of the Purchaser.
5. The Auctioneers or the Vendors do not guarantee the measurements catalogued, or the correct description, genuineness or authenticity of any lot.
6. Each purchaser shall pay the whole amount of his purchase money (Auctioneer's Commission payable by purchaser) for all lots bought by him before any lot or lots can be removed and the whole amount due from each purchaser must be absolutely paid on each day of the sale and if not paid within such time, all moneys deposited in any part payment shall be absolutely forfeited and the Auctioneers will be at liberty to resell the lot or lots or any parts thereof remaining un-removed, by Public Sale or otherwise, without giving previous notice to the purchaser and any difference or deficiencies which may arise from, such re-sale, together with all expenses attending the same shall be made good by the purchaser.
7. The lots are sold with all faults and errors of description. No allowance can be made in any case, nor will the Vendors be answerable for any deficiencies in quantities or measurements when the purchaser, his agent, carrier or man employed by him has removed any part of his lot or lots from the premises. All lots purchased must be removed absolutely in the time specified and if not so removed may be resold by the Vendors.
8. The Purchaser shall be answerable for all damages occasioned by any injury or other lots, by the removal of lots purchased by them, or to the premises and to repair or pay damages to the owners of same before the removal of their lots from the premises. In the event of any persons interested in the premises, claiming the whole or any part of a lot before its removal there from or if in the Auctioneer's opinion, the removal of any lot will endanger or permanently damage any building, the Auctioneer may, by written notice to the purchaser of such lot delivered to him or his Agent, or sent by post to his abode or place of business last known to the Auctioneers, rescind the sale of any such lot. The purchaser shall then be repaid his purchase money but shall not have or make any other claim.
9. Such lot or lots as are not cleared away agreeably to the condition of this sale, will not only be forfeited and may be dealt with under last condition, but the purchaser shall pay every expense attending the removal of any such lot or lots, and the costs of making good any damage occasioned by such removal. No lots shall be removed until the day following the last day of sale.
10. If any dispute or difference arises about any lot, or any other subject, the same shall be settled by the Auctioneers, with the approval of the Vendors, whose determination shall be final and binding on all parties concerned.
11. The Auctioneers nor the Vendors do not accept any liability for personal injuries of any description sustained or caused by any reason whatsoever by any person while on the premises or otherwise.
12. Purchasers will pay 15% Auctioneers Commission (minimum fee £1) + VAT on the commission.





Ballycastle

**Quality Tools and Picture Framing Equipment followed by
Antique and General Furnishings, collectibles etc.**



**‘The Auction Rooms’ Main Street
Thursday 24th September @6.30pm**

A really good selection of useful tools including steel lathe, compressors, bench saws etc. Excellent picture framing equipment inc morsa mitre guillotine, mount cutting systems, trimmers, rules etc. Furniture includes, bookcases, display cabinets, tables, chairs etc Collectibles include masons ironstone, tea and dinner sets, belleek, crystal, pictures, prints etc.

**Viewing Tuesday and Wednesday 23rd and 24th September 2.00 – 5.00, and 6.30 – 8.30pm and day of sale
from 2.00 – 5.00pm. Viewers must obey social distancing rules and wear masks.**

Bids may be left prior to sale, telephone bids can also be arranged or view and bid online via

easyliveAuction.com



Telephone Number During Viewing & Sale
(028) 2076 9404 / 07860474956



- | | | | |
|----|---|-----|--|
| 1 | An Ornamental Pig in the Form of a Planter | 54 | A Good Boxed Lot |
| 2 | An Old Chimney Pot | 55 | A Good Boxed Lot |
| 3 | A Large Belfast Style Sink | 56 | A Good Boxed Lot, inc Some Sothering Irons |
| 4 | A Large Three Legged Pot and a Griddle | 57 | A 24 Volt Transformer |
| 5 | A Good Metal End Garden Bench | 58 | A Yellowstone Heater |
| 6 | A Metal Table Base | 59 | A Spirit Level, Rulers etc |
| 7 | A Woodworkers Bench | 60 | A Good Airmate Tornado 21025 Compressor |
| 8 | Two Jerry Cans | 61 | A Good Lot of Socket Sets |
| 9 | Two Jerry Cans | 62 | A Nice Small Anvil |
| 10 | A Wooden Extending Ladder | 63 | An As New Mac Alister Double Grinder |
| 11 | An Aluminium Extending Ladder and a Roof Ladder 'Stand Odd' | 64 | An Old Trophy, Taps, Torches etc |
| 12 | Two Good Metal Car Ramps | 65 | A Box of Picture Frames |
| 13 | A Set of Aluminium Steps | 66 | A Box of Picture Frames |
| 14 | A Good Aluminium Triple Extending Ladder | 67 | A Black and Decker Grinder and Discs |
| 15 | A Set of Sewer Rods | 68 | A Parkside Drill |
| 16 | A Good Pair of Transport Rails | 69 | A Good Rasp Set |
| 17 | Two Four Wheel Trolleys | 70 | A Concord 4600B Power Lawnmower |
| 18 | A Two Wheel Trolley | 71 | A Good Theodolite Set |
| 19 | A Two Wheel Trolley | 72 | A Mouse Sander / Polisher |
| 20 | A Good Horse Drawn Grubber | 73 | An Unusual Gas Heater |
| 21 | A Good Turnip Sower | 74 | A Heavy Duty JCB Drill |
| 22 | A Very Good Garden Roller | 75 | A Boxed Lot of Brushes, Scrappers etc |
| 23 | A Good Blacksmiths Vice | 76 | A 24 Volt Transformer |
| 24 | A Gas Tank Trolley | 77 | Two Good Boxed Lots |
| 25 | A Two Wheel Trolley | 78 | A 24 Volt Transformer |
| 26 | A Set of Aluminium Steps | 79 | A Lot of Threaded Bolts |
| 27 | A Pair of Good Speaker Horns | 80 | A Lot of Gardening Tools |
| 28 | A Good Griddle | 81 | Two Spirit Levels and a Square |
| 29 | A Two Wheel Trolley | 82 | A Lot of Backing Boards |
| 30 | A Good Lot of Pictures and Paintings | 83 | A Small Angle Grinder |
| 31 | A Black and Decker Bench and Stool | 84 | An Old Max Sievert Blow Torch |
| 32 | A Wooden Plate Rack | 85 | A Good Table / Bench Saw |
| 33 | A Black Kettle | 86 | A Paint Spraying Can and a Fret Saw |
| 34 | An Old Radio | 87 | Two Battery Charges and A Two Band Radio |
| 35 | A Lot of Buckets and a Coal Scuttle | 88 | A Boxed Lot, Clamp, Oil cans etc |
| 36 | An As New Gas Heater | 89 | A Lot of Saws |
| 37 | A Trailer Light Bar | 90 | A Very Good DeLonghi Dehumidifier |
| 38 | An Old Tilley Lamp | 91 | A Good Tool Box |
| 39 | A Wooden Square | 92 | Two Electric Cables |
| 40 | An Oil Painting 'Chocolate Lab' - Vivien Capling | 93 | A Electrolux Cleaner |
| 41 | A Large Lot of Picture Frames | 94 | A Box of Tools etc |
| 42 | A Coal Box and a Small Floor Safe | 95 | A Good Sundry Lot |
| 43 | A Nice Print 'Sun Flower Growers' | 96 | A Laser Light and a Spike Light Set |
| 44 | A T.O.A PA Amplifier | 97 | A Good Record Vice |
| 45 | A Boxed Lot | 98 | A Good Parkinson Vice |
| 46 | A Boxed Lot | 99 | Two Useful Boxed Lots |
| 47 | A Boxed Lot | 100 | A Very Good Large Blacksmiths Anvil |
| 48 | A Box of Plaques and Merchandise | 101 | A Very Good Parkside Grinder |
| 49 | A Lot of Woodworm Killer, Thinners etc | 102 | A Boxed Lot, Light Fittings etc |
| 50 | A Good Sutton Bench Saw | 103 | A Good Fire Crane |
| 51 | A Projector, Table and Screen | 104 | A Useful Set of Shelves |
| 52 | A Lot of Remote Control Cars | 105 | A Good Tool Box and Contents |
| 53 | A Submersible Water Pump | 106 | A Good Welder, Sheild and Rods |
| | | 107 | A New Multi Work Bench |

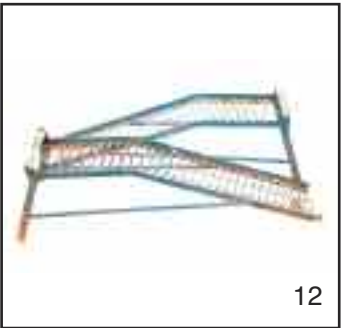
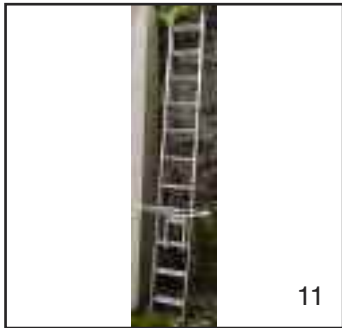

- 108 A Boxed Lot Staplers etc
 109 An As New Parkside Drill
 110 A Small Visilux and Small TV
 111 A Battery Charger
 112 A Wooden Sculpture
 113 A Pair of Wooden Swords
 114 Three Wooden and Metal Clamps
 115 A Very Good Dewalt Planer and
 Its Stand
 116 A Very Good Elu Bandsaw
 117 A Very Good Electric Press
 118 A Large Lot of Screwnails etc
 119 A Black Magic Hedge Trimmer
 (needs charger)
 120 A Tool Box and Contents
 121 A Good Pulley
 122 A Box of Storage Units and Their
 Contents
 123 A Black and Decker Sander and a Torch
 124 Two Stanley Planes and a Hand Drill
 125 A Boxed Lot, Saws etc
 126 A Boxed Lot Tools etc
 127 A Boxed Lot Tape, Picture Cord etc
 128 Three Small Wooden Easels
 129 Three Small Wooden Easels
 130 A Good Mitre Saw
 131 A Good Box of Dyes etc
 132 A Simple V Groover
 133 A Boxed Lot, Picture, Hangers etc
 134 A Good Box of Wrenches etc
 135 A Very Good Router and Bits
 136 A Cased Power Polisher
 137 Two Stage Lights
 138 A Large Lot of Cables
 139 Two Pro Sound Speakers and Stands
 140 A 'Big Boy' Scooter
 141 Two Power Lights on Stands
 142 A Good Lot of Cling Film etc
 143 An As New Leaf Blower
 144 A Box of Old Lamps, Gas Burner etc
 145 A Boxed Lot, Corner Clamp etc
 146 A Good Assorted Lot
 147 A Removers / Transport Trolley
 148 A Megaphone
 149 A Nu Power Sander
 150 An Octopma Digital DVD Projector
 151 A Black and Decker
 152 A Small Power Saw
 153 A Lervia Polisher
 154 A Box of Door Handles, Locks etc
 155 A Trestle Table
 156 A Very Good Box of Clamps
 157 A Maplin Amplifier
 158 A Wireless P.A System
 159 A Battery Charger and a Box of
 Rawlbolts etc
 160 A Very Good Koln Merctools Bench Saw
 161 A Record Stilson
 162 A Record Stilson
 163 Two Good Boxed Lots
 164 Two Speaker Horns
 165 A Box of Paper Towels and Dispensers
 166 A Box of Picture Frames
 167 A Drill Stand and a Vice
 168 A Box and Roll of Cables
 169 Two Transformers
 170 A Good Macalister Blow Torch
 171 A Box of Bits, Drill Cutters etc
 171A A Gas Burner Head
 172 Two Good Pro Sound Stands
 173 A X5 SWI Drone
 174 A Box of Mic Stands etc
 175 Two Weight Blocks
 176 An Old Canada Box and a Cast
 Metal Cat
 177 A Very Good Angle Vice
 178 A Lot of Gardening Tools
 179 A Set of Aluminium Steps
 180 A Very Good Morsa Mitre Machine
 181 A Good Bench Vice
 182 A Good Large Bench Vice
 183 A Very Good Ultimate Mount Cutter
 184 A Black and Decker Workmate
 185 A Lot of Woodsaws
 186 A Set of Pruners and a Sythe
 187 A Hydraulic Jack
 188 A Very Good Storage Tray Set and
 Contents
 189 Two Metal Trestle Stands
 190 A Very Good System 4000 Glass /
 Mounting Card Cutter
 191 A very Good Under Pinner
 192 A Nilflisk Hoover
 193 Two Tree Pruners
 194 A Jumbo Air Compressor
 195 A Parkside Compressor
 196 A Fret Saw
 197 A Box of Wood Planes
 198 Two Boxes of Tools
 199 A Stanley Plane and a Lot of Squares
 200A An Origan Shrinkwrap Machine
 200 A Very Good Hot Press
 201 An Erskins Compressor
 202 A Black and Workmate
 203 A Good Clarke Double Grinder
 204 A Small Hacksaw
 205 A Very Good As New ABAC Compressor
 206 A Tormek 2000 Grinder
 207 Two Walking Aids
 208 A Hand Press
 209 A Lew Power Washer
 210 A Very Good Myford Steel Lathe and its
 attachments

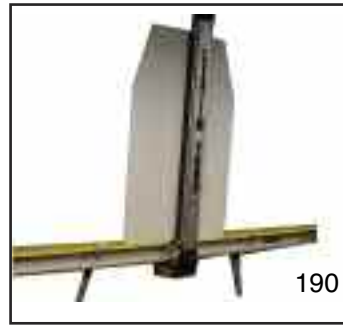
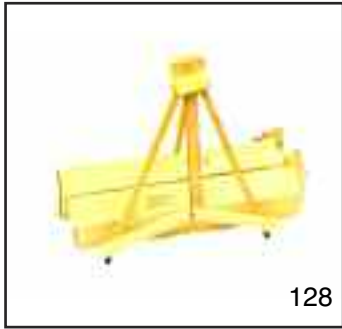

- 210A A Boxed Lot, Spirit Level, Hand Lamp etc
- 211 A Car Dent Repair Kit
- 212 A Very Good Die Set
- 213 Three Oil Cans and a Grease Gun
- 214 A Tool Box and Contents
- 215 A Very Good Ajax Pillar Drill
- 216 Two Rebating Planes and a Vice
- 217 Three Good Boxed Lots
- 218 Two Paint Guns and a Grease Gun
- 219 A Boxed Lot including a Grease Gun Etc
- 220 A Very Good APTG Electric Hack Saw
- 221 A Good Double Grinder
- 222 A Wooden Box and Contents
- 223 A Brown and Polsons Box and Contents
- 224 A Lot of Gardening and Other Tools
- 225 A Seagull Power Motor
- 226 A Four Drawer Metal Filing Cabinet
- 227 An Alsafe Security Box
- 228 Two Useful Boxed Lots, Blades, Tools etc
- 229 A Woodworking Lathe (needs motor) and its Chisels
- 230 An As New Cebord Welder
- 231 A Small Bandsaw
- 232 Two Boxed Lots, Clamps etc
- 233 A 140 Welder
- 234 A Belt Sander
- 235 A Small Anvil and a Clarke Jack
- 236 A Very Good Lot of Engineering and Wood Bits
- 237 An Electric Wire Brush Cleaner
- 238 A Lot of Garden Tools and a Clamp
- 239 A Lot of Copper Wire
- 240 A Large Lot of Picture Frame (six Bundles)
- 241 A Lot of Tapestries
- 242 Three Pastel Drawings
- 242A An Oil Painting 'Sailing Boat' - K Orrayed
- 243 An Oil Painting and a Print
- 244 A Nice Print 'Poppy' and a Gilt Frame
- 245 Two RMS Titanic Posters
- 245A A Good Floor Rug
- 246 Five Original Chris Deardon Works
- 247 Five Original Chris Deardon Works
- 248 Five Original Chris Deardon Works
- 249 Five Original Chris Deardon Works
- 250 Five Original Chris Deardon Works
- 251 Five Original Chris Deardon Works
- 252 Five Original Chris Deardon Works
- 253 Five Original Chris Deardon Works
- 254 Five Original Chris Deardon Works
- 255 Five Original Chris Deardon Works
- 256 Five Original Chris Deardon Works
- 257 Five Original Chris Deardon Works
- 258 Five Original Chris Deardon Works
- 259 Five Original Chris Deardon Works
- 260 Five Original Chris Deardon Works
- 261 Five Original Chris Deardon Works
- 262 Five Original Chris Deardon Works
- 263 Five Original Chris Deardon Works
- 264 Five Original Chris Deardon Works
- 265 Two Original Chris Deardon Works
- 266 Two Original Chris Deardon Works
- 267 Two Original Chris Deardon Works
- 268 A Framed Work ' Life of the Land' - R Sellar
- 269 A Collection of Prints and Posters
- 270 A Concord Sovenir Poster
- 271 A Lot of Five Mounted Prints
- 272 Two Framed Chris Deardon Watercolours
- 273 Three Winnie the Pooh Framed Prints
- 274 A Box of Mounted Prints
- 275 A Large Gilted Framed Mirror
- 276 A Good LG Flatscreen TV and Its Stand
- 277 A Centre Light Fitting and a Pair of Wall Lights
- 278 A Very Good, As New Mormande Dishwasher
- 279 A Watercolour 'North Antrim Coast'
- 280 An Oil Painting 'Evening Light, Ballintoy' - Jack Wilkinson
- 281 A Three Fold Cakestand and a Nice Gilted Magazine Rack
- 282 A Nice Oak Two Door Bookcase / Display Cabinet
- 283 A Good Centre Light Fitting
- 284 A Sundry Lot of a Metronome, Golf Figurine etc
- 285 A Box of French Chocolate Makers Biscuit Moulds
- 286 A Nice Painted and Pine Dresser
- 287 A Framed Oil Painting and a Picture of Glenarriff
- 288 A Nice Small Three Drawer Bow Fronted Chest
- 289 A Nice Modern Centre Light Fitting
- 290 A Very Good Old Brass Telescope and Its Original Box
- 291 An Old Style Door Bell
- 292 A Side Cabinet Fitted Drawers
- 293 A 9 Branch Centre Light Fitting and a Similar Wall Light Fitting
- 294 A Pair of 5 Branch Centre Light Fittings
- 295 An Extending Dining Room Table and Six Pine Chairs
- 296 An Oil Painting ' Ballycastle ' - Jack Wilkinson
- 297 A Pair of Gilt Framed Pictures and Another Similar Picture



205



210



220



221



223



230



233



234



237A



246



252



255



259



261



268



278



280



282



285



286



288



290

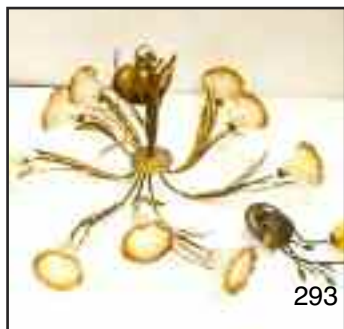

293



296

- 298 An Inlaid Mahogany Glazed Bookcase
- 299 A Good Carved Oak Based Standard Lamp and Shade
- 300 An Oil Painting 'Bringing Home the Turf' - Donal McNaughton
- 301 An Oil Painting 'Days Work Done' - Donal McNaughton
- 302 An Oil Painting 'Moet and Chandon, Champagne' - Spillane
- 303 A Good Rectangular Blue Rug and Matching Lamp Shade
- 304 A Good Wing Backed Armchair
- 305 A Good Mahogany D End Side Table
- 305A A Good Mahogany Hall Chair
- 306 A Nice Early Framed Print 'Breakfast Time'
- 307 An Oak Cased Wall Clock
- 308 A Very Nice Double Figurine Mantle Clock
- 309 A Very Nice Pair of Mahogany Framed Armchairs
- 310 A Watercolour 'North Antrim Coast' - Sam McLarnon
- 311 A Mantle Clock Under Dome, Presented by Coleraine Bowling Club
- 312 A Brass Corinthian Pillar Table Lamp and Shade
- 313 An Oval Floor Rug
- 314 An Oil Painting 'Wellies' - R Keefer
- 315 A Very Good Mahogany Partners Desk, Leather Top
- 316 A Very Nice Inlaid Mahogany Cutlery Box
- 317 A Very Nice Inlaid Mahogany Cutlery Box
- 318 A Good Collection of Victorian Style Prints
- 319 A Large Carpet Square
- 320 A Very Good Pair of Chandeliers
- 321 A Set of Six Nicely Framed Prints
- 321A A Very Nice Modern Copperised Table Lamp and Shade
- 322 An Old Pokerwork Stool
- 323 A Very Nice Mahogany Glazed Dresser
- 324 A Good Folding Card Table
- 325 A Mahogany Longcase Clock, Brass Dial
- 326 A Large Blue and White Ginger Jar
- 327 A Nice Decorated Glass and Gilted Metal Centre Light Fitting
- 328 A Nice Gilt Framed Wall Mirror
- 329 A Large Circular Pine Wall Clock
- 330 A Large Pine Open Top Dresser
- 331 A Large Collection of Blue and White Ware
- 332 A Small Dressing Mirror, Oil Lamp Burner, Copper etc
- 332aA Hotwater Bottle and a Tray and Contents
- 332b A Sundry Lot Inc Table Lamp etc
- 333 A Nice Inlaid Mahogany Music / Display Cabinet
- 334 A Single Kitchen Chair
- 335 A Good Pine Kitchen Table and Six Chair Set
- 336 An Old Hot Water Bottle
- 337 A Painting of a Dogs Head and an Embroidered Picture of Another
- 338 A Lot of Horse Brasses and a Horse Bit
- 339 A Nice Mahogany Framed Nursing Chair
- 340 A Good Pine Side Table, Three Drawers
- 341 A Phillips Flatscreen TV
- 342 A Very Good Part Denby Tea and Dinner Service
- 343 A Mahogany Framed Dressing Mirror on Stand
- 344 A Mahogany and Brass Mounted Coal Scuttle, for Restoration
- 345 A Good Pine Lidded Blanket Box
- 346 A Nice Oval Coffee Table
- 347 A Good Painted Kitchen Armchair
- 348 A Rare Shoe Sized Ruler with Brass Decoration
- 349 Three Old Wooden Rulers
- 350 A Very Early Old Singer Sewing Machine on Base
- 351 A Box of Assorted Cutlery
- 352 A Collection of Ornamental Birds etc
- 353 Two Treen Shoe Stretchers and Two Old Corkscrews
- 354 A Ladies and Gents Upholstered Armchair
- 355 An Old Singer Sewing Machine
- 356 An Oak Two Door Bookcase
- 357 A Slate Mantle Clock
- 358 A Nice Brass Lamp Base
- 359 A Good Table Cloth and a Set of Napkins
- 360 A Painted Coffee Table
- 361 A Nice Framed Print 'Sheep on the North Antrim Coast' - Keith Glasgow
- 362 Two Auctioneers Gavels and a Wooden Paper Rack
- 363 A Watercolour 'Mussenden' - Sam McLarnon
- 364 A Nice Upholstered Nursing Chair
- 365 A Five Drawer Music Cabinet
- 366 A Gilt Framed Picture Frame
- 367 A Large Framed Print 'Market Day'
- 368 An American Bull Ornament
- 369 A Large 'Teardrop' Ruby Vase
- 370 A Pair of Carltonware Apple Blossom Graduated Jugs
- 371 A Figurine 'Vernona'



298



300



301



314



315



317



318



320A



321



323



325



328



330



333



335



345

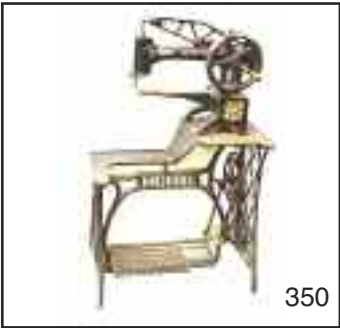

350



361



363



368



370



371



372



380

- 372 A Royal Doulton Lambeth Jug and Tankard
- 373 Two Art Deco Shelley Trios
- 374 A Royal Winton Chinz Lidded Bowl and a Carltonware Cruet Set
- 375 A Clarice Cliff 'Celtic' Harvest Jug
- 376 A Clarice Cliff 'Celtic' Harvest Preserve Pot
- 377 A Carltonware Buttercup Bowl
- 378 An Extending Brass Fender
- 379 A Nice Walnut Nest of Three Tables
- 380 A Very Nice Pair of Leather Covered Button Back Armchairs
- 381 A Mahogany Occasional Table
- 382 A Very Nice Pair of Gilted and Decorated Vases
- 383 A Very Similar Oval Shaped Fruit Bowl
- 384 A Mahogany Turn Over Leaf Card Table
- 385 A Nice Walnut Framed Upholstered Stool
- 386 A Good Turn Over Leaf Card Table
- 387 A Kidney Shaped Nest of Three Tables
- 388 A Gilt Table Lamp Base
- 389 A Mahogany Framed Open Armchair
- 390 A Hunters Cap and a Fur Bag
- 391 A Mahogany and Two Door Bookcase with Top
- 392 A Phoenix Powered Off Road Stadium Truck
- 393 Three Pieces of Donegal China and a Two Handled Pot
- 394 A Masons Ironstone Vase and Two Pieces of Aynsley and a Pair of Vases
- 395 A Belleek Mantle Clock, Belleek Dish and a Donegal China Tray
- 396 A Pair of Tall Belleek Vases
- 397 Two Belleek Flower Pots
- 398 A Lot of Masks and Caps
- 399 A Lot of Framed Prints
- 400 A Very Good Drop Dial Fusee Wall Clock
- 401 A Lot of Early Tiles
- 402 A Collection of Trophies
- 403 A Shelf Lot of Brass and Copper
- 404 A Shelf Lot of Belleek etc
- 405 A Box of Bone Handled Cutlery
- 406 A Box Lot including a Pair of Candleholders
- 407 A Gilt Framed Wall Mirror
- 408 An Electric 'Westfield' Guitar
- 409 A Pair of Silver Plated Candleabra and Tray
- 410 A Good Standard Lamp and Shade
- 411 A Bone Handled Carving Set and a Lot of Cutlery
- 412 A Large Assorted Lot of Ceramics
- 413 A Nice Mahogany Hall Table
- 414 A Brass Mounted and Inlaid Box
- 415 A Six Piece Mahogany Framed Parlour Suite
- 416 A Nice Mahogany Framed Button Back Armchair
- 417 A Copper Bound Oak Planter
- 418 A Carved Back Single Chair
- 419 A Pair of Upholstered armchairs
- 420 An Upholstered Armchair
- 421 A Wooden Towel Rail
- 422 A Nice Mahogany Cased Granddaughter Clock
- 423 A Nice Circular Mahogany Occasional Table
- 424 An Interesting Lot of Ceramics
- 425 An Oil Painting 'Still Life' - R Keefer
- 426 An Oil Painting 'Nosey Cow' - Con Campbell
- 427 A Small Oak Stool
- 428 A Small Two Seater Couch
- 429 A Talisman Wall Clock
- 430 A Very Nice Inlaid Mahogany Corner Cabinet
- 431 A Pokerwork Cakestand and Two Others
- 432 A Mahogany Wall Unit
- 433 An Oil Painting 'Landscape' - D Dale
- 434 An Early Writing Desk, leather Inset
- 435 A Large Gilt Framed Over Mantle
- 436 A Nice Kidney Shaped Upholstered Stool
- 437 A Walnut Occasional Table Centre Drawer
- 438 An Octagonal Mahogany Occasional Table
- 439 A Painted Towel Rail
- 440 A Nice Mahogany Framed Button Back Three Piece Suite
- 440A A Pair of Oil Paintings 'Still Life'
- 441 A Slimline Drop Leaf Occasional Table
- 442 Two Old Pairs of Ice Skates
- 443 A Lot of Old Ceramics
- 444 A Nice Modern Pine Chest of Three Drawers
- 445 A Mahogany Side Table / Desk, three Drawers
- 446 Three Part China Teaset
- 447 A Slimline Pine Bookshelf
- 448 A Modern Nest of Three Tables
- 449 A Pair of Finger Lamps
- 450 A Framed Oil 'The White Strand' - J P Rooney
- 451 A Framed Oil 'Memories on the Pier' - J P Rooney
- 452 A Nice Inlaid Mahogany Upholstered Tub Chair
- 453 An Embossed Brass Stick Stand



382



384



385



386



387



391



393



396



400



408



415



416



419



422



428



430



433



435



436



445



447



450



451



453

- 454 A Single Balloon Back Chair
- 455 A Nice Pair of Small Upholstered Armchairs
- 456 A Lot of Five Walking Canes
- 457 A Lot of Three Walking Canes
- 458 A Mahogany Two Door Bookcase
- 459 An Interesting Lot of Books and Two Pieces of Silver Plate
- 460 A Mahogany Two Door Bookcase
- 461 A Large Circular Overpot
- 462 A Masons Ironstone Overpot
- 463 A Masons Ironstone Footed Dish
- 464 A Masons Ironstone Footed Bowl
- 465 A Good Mahogany Dining Room Table
- 466 An Upholstered Single Chair
- 467 A Pair of Royal Doulton Plates 'The Hunts Man' and 'The Doctor'
- 468 A Pair of Nice Framed Pictures 'Riverscenes' - J E Hanna
- 469 An Old Pine Stool
- 470 An Early Circular Extending Table, Leather Inset
- 471 A Framed Print 'Giants Causeway' and Another
- 472 An Inlaid Mahogany Oval Coffee Table
- 473 A Nice Framed Print of a Gent, After Binley
- 474 Three Nice Framed Pictures 'Cats'
- 475 A Circular Occasional Table Paw Feet
- 476 A Art Deco Canteen of Cutlery
- 477 A Very Nice Inlaid Four Shelf Whatnot
- 478 A Nice Mahogany Framed Rocking Chair
- 479 A Childs Folding Chair
- 480 An Inlaid Mahogany Writing Desk
- 481 A Figurine Based Table Lamp and Shade
- 482 A Very Nice Brass Framed Bevelled Glass Wall Mirror
- 483 A Royal Albert Old Counrty Rose Teaset
- 484 A Lot of Part Teasets etc
- 485 An Upholstered Button Back Armchair
- 486 An Oil Painting 'Fairhead' - J J O' Neill
- 487 A Nice Figurine of a Falcon
- 488 A Nice Mahogany Bedside Cabinet
- 489 A Painted Bowl Oil Lamp
- 490 A Very Good Mahogany Library Table
- 491 Two Very Nice Carved Trays
- 492 A Very Nice Pair of Gilt Framed Prints
- 493 A Nice Pair of Watercolours ' North Antrim Coast' - Sam McLarnon
- 494 A Framed Print 'Sheep Near Dunluce' - Keith Glasgow
- 495 A Nice Oak Drop Leaf Table
- 496 A Set of Brass Fire Irons and Dogs
- 497 A Walnut Bedside Cabinet
- 498 A Centre Light Fitting
- 499 An Oil Painting 'Wooded Walk' - A Campbell
- 500 A Nice Astragal Glazed Inlaid Mahogany Display Cabinet
- 501 The Contents of the Display Cabinet
- 502 A Framed Oil 'North Antrim Coast' - William Cunningham
- 503 A Framed Oil 'Juggling Jim' - Roy Wallace
- 504 A Good Brass Mounted and Inlaid Coal Scuttle
- 505 A Shaped Front Side Table and an Oak Single Chair
- 506 A Nice Nao Figurine 'Girl at Well'
- 507 A Nice Crystal Footed Bowl
- 508 A Tapestry Top Dressing Table Stool, Paw Feet
- 509 Two Masons Ironstone Plates and Two Masons Ironstone Jugs
- 510 An Astragal Glazed Display Cabinet
- 511 A Large Collection of Royal Albert and Other China
- 512 A Nice Tear Drop Set of Mahogany Bookshelves
- 513 A Dressing Mirror on Stand
- 514 A Pair of Leather Upholstered High Backed Chairs
- 515 A Nice Mahogany Occasional Table, Centre Drawer
- 516 An Early Jug and Basin Set
- 517 A Set of Three Mahogany Bar Back Chairs
- 518 A Painted Brass Mounted Coal Scuttle
- 519 A Mahogany Framed Stool
- 520 An Inlaid Mahogany Open Armchair
- 521 An Early Framed Print and a Painting of a Tortoise
- 522 A Large Pair of Masons Ironstone Ginger Jars
- 523 A Wooden and Metal Shelf Unit
- 524 A Small Nest of Oak Tables
- 525 A Four Piece Stag Bedroom Suite
- 526 A Nice Pair of Electrified Oil Lamps
- 527 A Tea Company Sign
- 528 A Watercolour 'North Antrim Coast' - Sam McLarnon
- 529 An Oil Painting 'Ploughing' - Gregory Moore
- 530 A Nice Inlaid Mahogany Sutherland Table
- 531 A Good Rectangular Floor Rug
- 532 A Large Box of Cigarette Cards
- 533 A Slimline Folding Table
- 534 An Old Teddy Bear
- 535 A Small Astragal Glazed Corner Cupboard



456



458



460



463



466



472



476



477



478



479



480



483



487



488



490



492



499



502



503



510



513



518



526



528

- 536 A Pair of Silver Plated Candleabra and a Silver Plated and Crystal Cruet Set
- 537 An Early Oak Corner Cupboard
- 538 A Mahogany Framed Fire Screen, Tapestry Panel
- 539 A Heavy Brass Companion Set in the Form of a Dog Begging
- 540 An Oil Painting 'Roundstone Harbour' - Hamilton Sloan
- 541 Two Framed Prints 'Crossing the Brook' & 'Washtime'
- 542 A Framed Print, Wall Mirror and Picture Frame
- 543 A Turn Over Leaf Card Table
- 544 An Early Wooden Stool
- 545 An Office Chair
- 546 An Old Wash Board
- 547 A Watercolour 'Cushendun' - David Livingstone
- 548 A Watercolour 'The Lighthouse' - Signed
- 549 A Character Sketch - Kane
- 550 A Large Four Fold Decoupage Scree
- 551 A Drop Leaf Table
- 552 A Small High Chair
- 553 An Old Wooden Box and a Flagon
- 554 A Nice Carved Box
- 554A A Nice Carved Box
- 555 A Pine Dressing Table
- 556 A Good Old Flagon and an Oil lamp Burner
- 557 Two Old Mantle Clocks
- 558 A Nice Mirror Backed Dressing Table
- 559 A Brass Based Table Lamp and Lustre Shade
- 560 A Good Helmet Shaped Coal Scuttle
- 561 A Gilt Framed Oil Painting
- 562 An Early Childs Chair
- 563 A Pine Chest of Drawers
- 564 A Set of Brass Fire Dogs and Irons
- 565 A Nice Pair of Table Lamps
- 566 A Nice Modern Pair of Well Framed Prints
- 567 A Good Childs Cot
- 568 An Old Bushmills Framed Print
- 569 A Pair of Limited Edition Still Life Prints
- 570 A Nice Small Oak Mirror Backed Sideboard
- 571 A Royal Doulton Figurine 'Dream Weaver'
- 572 A Royal Doulton Figurine 'Buddies'
- 573 A Very Early Pair of Staffordshire Dogs (as seen)
- 574 A Mahogany Occasional Table
- 575 A Nice Firescreen Hand Crafted Panel
- 576 A Slimline Mahogany Side Table
- 577 An Embossed Coal Box, Original Liner
- 578 A Brass Trivet, Teapot and a Shell Case
- 579 An Unusual Ornamental Tree on Onyx Base
- 580 A Very Nice Shaped Front Mahogany Coal Scuttle, Gilted Mounts
- 581 A Nice Oak Occasional Table
- 582 A Nice Oak CD Cabinet
- 583 A Single Bar Back Chair
- 584 A Very Nice Oak Stick Stand
- 585 A Carved Oak Coal Box
- 586 An Oval Walnut Table
- 587 An Early Staffordshire Lion
- 588 A Lyle and Kinnahan Soda Syphon
- 589 A Good Floor Runner
- 590 A Nice Upholstered Armchair
- 591 A Good Collection of Old Silver Plate, Two Shelves
- 592 A Large Collection of Coronation Tankards
- 593 A Good Lot of Mainly Cutlery
- 594 A Nice CD Holder
- 595 A Nice Old Spirit Decanter
- 596 An Oil Painting 'Swan Lake'
- 597 A Brass Bed Warmer
- 598 A Framed Oil 'Winter Stroll' - Paula McKinney
- 599 A Framed Oil 'Tally Ho!' - Roy Wallace
- 600 An Oil Painting 'Horse' - Con Campbell
- 601 A Pair of Framed Watercolours - Evy Porter
- 602 A Small Oak Wall Clock
- 603 An Unusual Table Lamp and Shade
- 604 An Art Deco Style Standard Lamp and a Glass Shade
- 605 A Nice Set of Mahogany Bookshelves, drawers above
- 606 The Contents of the Bookshelves
- 607 A Nice Mirror Backed Hat / Coat Hanger
- 608 A Circular Walnut Coffee Table
- 609 An Interesting Figurine of a 'Cheetah and Family'
- 610 A Brass Pillar Oil Lamp, Ruby Bowl
- 611 A Brass Fire Front
- 612 A Brass Fender
- 613 A Capodimonte Figurine 'Grandas Tales'
- 614 A Modern Tilley Lamp and an Oil Lamp Burner
- 615 A Very Nice Oak Fall Front Writing Bureau
- 616 A Nice Oak Two Door Small Cupboard
- 617 A Similar Small Occasional Table with Drawer
- 618 A Large Ceramic Figurine of a Cow
- 619 A Set of Pine Open Bookshelves
- 620 Two Brass Table Lamps and Shades



- 621 A Slimline Mahogany Table, Two Drawers
- 622 A Tapestry Top Long Stool
- 623 An Old Gramophone Cabinet, Coverted to an Automan
- 624 An Early Oil Painting 'Landscape' - Knight
- 625 A Very Nice Inlaid Mahogany Open Armchair
- 626 A Mahogany Stick Stand
- 627 A Long Upholstered Buttoned Top Stool
- 628 A Nice Set of Three Birds of Britain Wall Plaques
- 629 A Good Kitchen Armchair
- 630 A Very Early Carved Backed Swivel Armchair
- 631 A Very Good Denby Tea and Dinner Set
- 632 A Very Nice Mahogany Two Door Side Cabinet, Drawer Above
- 633 A Very Nice Oak Framed Armchair, Rush Seat
- 634 A Very Interesting Oak Panel Door Fitted Wardrobe
- 635 A Very Nice Inlaid Mahogany Three Door Bookcase
- 636 A Mahogany Loncase Clock, Painted Dial, Weir of Coleraine
- 637 A Mahogany Framed Oval Wall Mirror
- 638 A Mahogany Occasional Table
- 639 A Framed Oil 'Curious Cow' - Con Campbell
- 640 A Very Nice Mahogany Occasional Table
- 641 A Watercolour 'Lissanoure' - Jack Wilkinson
- 642 An Interesting Lot of Ceramics
- 643 A Very Nice Chest of Drawers
- 644 An Early Childs Teaset
- 645 A Nice Brass Figurine Based Oil Lamp and Shade
- 646 A Lot of Nine Circular Glass Discs
- 647 A Nice Mahogany Bedside Cabinet
- 648 An Old Vintage Pram
- 649 An Early Circular Snap Top Table
- 650 A Nice Charcoal Drawing of a Lady
- 651 A Watercolour 'Landscape' - A Kernohan
- 652 A Double Weight Vienna Wall Clock
- 653 A Nice Mahogany Two Door Wall Cabinet
- 654 A Very Nice Pair of Early Rail Back Chairs, Leather Seats
- 655 A Very Nice Mahogany Framed Leather Button Easy Chair
- 656 A Good Inlaid Mahogany Wardrobe, Drawers Below
- 657 A Very Good Pair of Upholstered Wing Backed Armchairs
- 658 An Oval Mahogany Occasional Table
- 659 A Nice Mahogany Framed Fire Screen, Twisted Column, Beadwork Panel
- 660 A Very Good Rectangular Carpet Square
- 661 A Nice Upholstered Long Stool
- 662 An Mahogany Single Chair
- 663 A Very Nice Shaped Front Decorated Table, Gilt Mounts, Three Drawers
- 664 A Very Fine Revolving Piano Stool, Carved Pedestal
- 665 A Slimline Mahogany Set of Bookshelves
- 666 A Gilt Framed Print 'The Falcons Twilight', Signed David Pentland and Another First Flight of the Spitfire'
- 667 Two Framed Pictures
- 668 A Pair of Nice Belleek Figurines 'The Basket Carriers'
- 669 A Pair of Belleek Candlesticks
- 670 A Lot of Hat Pins
- 671 An Old Safe Badge, T Ramsey, Belfast
- 672 A Good Lot of Photographs, HMS Belfast, Coventry, Warspite, Arch Royal etc
- 673 A Lot of Cigarette / Tea Card Albums
- 674 A Good Shelf of Blue and White Ware
- 675 Three Nice Hip Flasks
- 676 An Unusual Collection of Small Dolls
- 677 A Lot of Small Trinket Boxes, Brass crocodile etc
- 678 A Keltcraft by Noritake Teaset
- 679 An Interesting Sundry Lot including Bunnykins ware
- 680 Six Belleek Living Mugs and Five Etched Glasses
- 681 A Desk Thermometer
- 682 Two Old Chamber Pots
- 683 A 9ct Gold Five Stone Ring
- 684 A 9ct and Palladium Three Stone Ring
- 685 Two Silver Medals 'Ballymena Feis and Doire Feis' Birmingham 1925



629



630



632



633



634



635



636



641



643

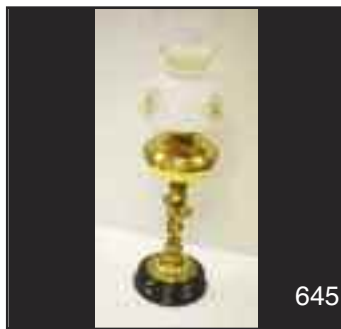

645



648



653



654



655



656



657



661



663



665



667



672



673



675



681

mcafee



51 Main Street, Ballymoney, BT53 6AN, Tel: (028) 2766 7669